

Private Car Insurance Policy

www.markerstudy.com

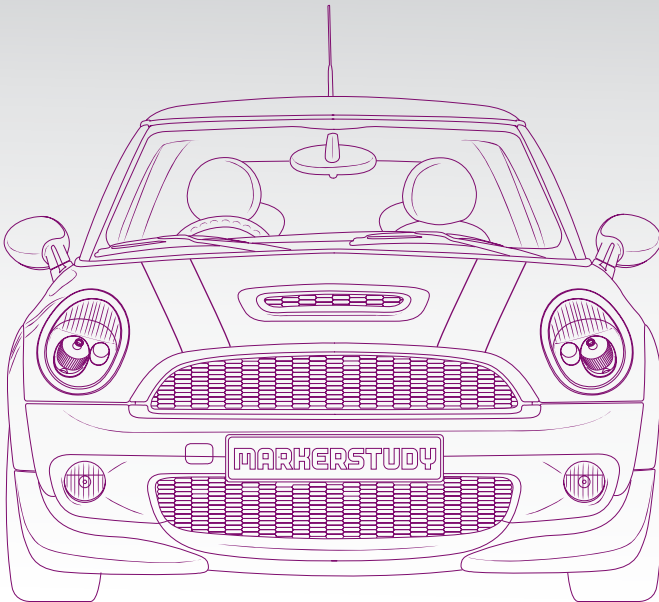

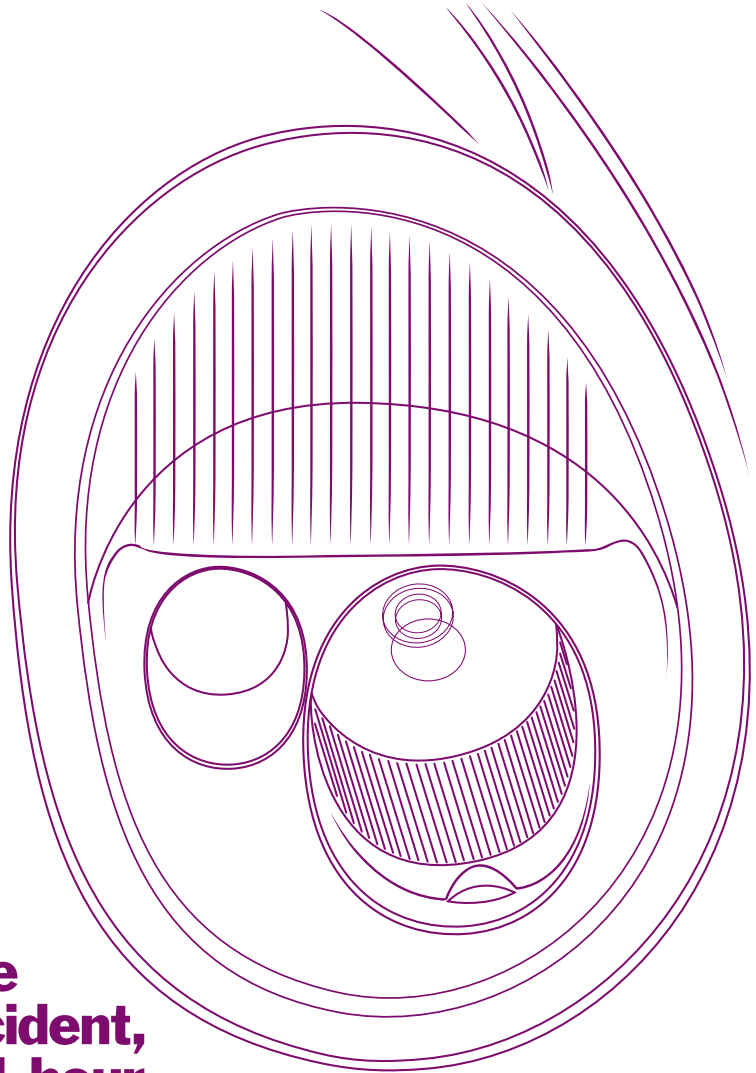

**If you have
had an accident,
call our 24 hour
Claims Helpline:
0844 873 8183**

Please call within 24 hours of the accident, but **ideally within 1 hour**.
You may be entitled to a **FREE** courtesy car, **FREE** collection and delivery,
and we can provide a windscreen replacement service.

Important Customer Information	3
What to do in the Event of an Accident	4
Introduction to Your Policy	5
Definitions	6 - 7
Insurance Provided - Guide to Policy Cover	8
Section A - Loss of or Damage to the Insured Vehicle	9 - 11
Section B - Loss of or Damage to the Insured Vehicle by Fire and Theft	12 - 15
Section C - Liability to Other People	16 - 17
Section D - Provision of a Courtesy Car	18
Section E - Personal Accident Benefits	19
Section F - Personal Belongings	20
Section G - Medical Expenses	20
Section H - Glass Damage	21
Section I - Replacement Locks	22
Section J - Foreign Use of the Insured Vehicle	23 - 24
Section K - No Claim Discount	25
Section L - Protected No Claim Discount	26
General Exceptions	27 - 28
General Conditions	29 - 32
Endorsements - Only applicable if shown on your Policy Schedule	33 - 34
Our Service Commitment	35 - 36
Data Protection and Sharing Information with Other Organisations	37 - 38
Notes - Space for your own written comments	39 - 40
Accident Cards and Numbers to Call	41 - 42

Important Customer Information

Pages 3 and 4 are for your guidance and do not form part of the insurance contract.

You should keep a complete record of all information (including copies of letters) supplied to us in taking out this insurance.

So that you understand what you are covered for, please read this policy, the Policy Schedule (which may make reference to endorsements) and the Certificate of Motor Insurance very carefully. You should pay special attention to the General Exceptions and General Conditions of this policy.

If you have any questions, or the cover does not meet your needs or any of the details are incorrect you should notify us immediately via your insurance intermediary.

Notification of changes which may affect your insurance

To keep your insurance up to date please tell us straight away via your insurance intermediary about changes which may affect your cover.

Some examples are:

- A change of car, or you have purchased another car to which you want your existing cover to apply.
- You wish a new driver to be covered.
- You or any other driver passes their driving test.
- Someone who drives the car gets a motoring or other conviction or fixed penalty endorsement or suffers from a medical condition or has a claim on another policy.
- The car is changed or modified from the manufacturer's standard specification or you intend to change or modify it (including the addition of optional fit accessories such as spoilers, skirts, alloy wheels etc).
- A change of occupation (full or part-time) by you or any other driver.
- A change of postal address.
- A change of address at which the vehicle is kept.

- A change of garaging facilities/where the vehicle is normally left overnight.
- A change in the use of the car.
- The car is involved in an accident no matter how trivial.
- A change of the main user of the car.
- If the car is likely to exceed the annual mileage declared at the commencement or renewal of the policy for which you may have received a premium discount.

This is not a full list and if you are in any doubt you should advise your insurance intermediary for your own protection. If you do not tell us about changes, your insurance may not cover you fully or at all.

Guidance notes

There are useful guidance notes shown in purple shaded boxes throughout the policy document. The guidance notes do not form part of the insurance contract but are there to help you understand it. You should always read the guidance notes in conjunction with the whole of the policy document.

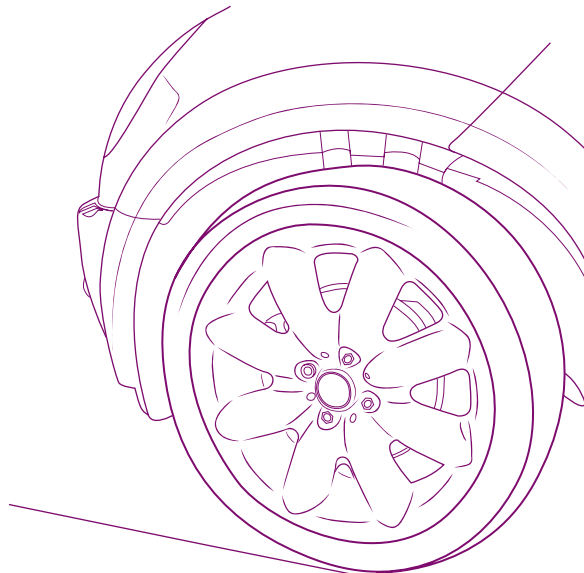

What to do in the Event of an Accident

Regardless of blame it is important that you take the following action:

Stop: Stop as soon as possible, in a safe place (if you have a warning triangle, place it well before the obstruction). If anybody has been injured, call the police and ambulance service.

Sketch: Make a quick sketch of the direction and final position of each vehicle (it is worth keeping a pen and paper in your car).

Note down: You will need to make a note of:

- The vehicle registration number, name, address and telephone number of any other drivers involved in the accident.
- The number of passengers in each vehicle.
- The name and address of anyone who is injured (or suggesting they have been injured).
- The name, address and telephone number of any witnesses to the accident.
- The name, telephone number and constabulary of any police officer who attends the accident.

Take a photo: If you have a mobile phone with you and it is fitted with a camera, try and take photographs to support the positions of the vehicles and the extent of damage.

Provide: You must give your own details to anyone who has reasonable grounds for requesting them.

DO NOT: Do not admit responsibility, either verbally or in writing. Instead, simply fill in the details of your policy onto the 'TO GIVE' accident card provided at the back of this booklet and hand it to the other driver(s)/ person(s) involved in the accident. By passing the accident card to the other person(s) involved in the accident you will give him/her the opportunity of obtaining our assistance in progressing repairs and assisting with the provision of a courtesy vehicle if the circumstances of the accident warrant this.

If for any reason you have not been able to exchange details with other drivers or owners of property or you were in collision with an animal, you must report the accident to the police as soon as possible, and certainly within 24 hours of the accident.

Contact us

**At the roadside?
Call 0845 266 8846**

To obtain immediate assistance at the roadside call our Roadside Priority Claims Helpline on 0845 266 8846.

Our UK based, experienced advisors will take initial claim details and discuss recovery of your vehicle.

**Unable to call from the roadside?
Call 0844 873 8183**

If you are unable to call from the roadside you must call our 24 hour Claims Helpline on 0844 873 8183 as soon as it is safe to do so.

Please call within 24 hours of the accident, but **ideally within 1 hour**. This is regardless of whether you wish to make a claim under the policy or not. **Delay in notification of an incident to us may invalidate your right to claim.**

Please quote your policy number and give all relevant information about the incident. If your claim is due to theft, attempted theft or vandalism you must also inform the police and obtain a crime reference number.

Benefits of an immediate call

Calling us straightaway provides you with benefits which may include the following (dependant on the level of policy cover you have):

- **FREE** courtesy car while your car is being repaired (subject to availability).
- Windscreen repair/replacement.
- **FREE** collection and re-delivery.
- **FREE** car cleaning service.
- Repairers' work guaranteed for three years.

We will deal with your claim and claims made against you, as quickly and fairly as possible. Please read the General Conditions in this policy booklet.

For our joint protection telephone calls may be recorded and monitored by us.

Introduction to Your Policy

Thank you for choosing to purchase a Markerstudy Insurance policy.

This policy document is evidence of a legally binding contract of insurance between you (the Insured) and us (Markerstudy Insurance Company Limited). The contract is based on the information you provided on your signed proposal form, or statement of fact or statement of insurance and any other information given either verbally or in writing by you or on your behalf at the time you applied for insurance.

You must read this policy document, the Policy Schedule and the Certificate of Motor Insurance together. The Policy Schedule tells you which sections of the policy apply. Please check all three documents carefully to make certain they give you the cover you want.

We have agreed to insure you against liability loss or damage that may occur within the geographical limits of the policy during any period of insurance for which you have paid, or agreed to pay the premium. The cover we provide is subject to the terms, conditions and exceptions contained in this policy document or in any endorsement applying to this policy document.

Nobody other than you (the Insured) and us (Markerstudy Insurance Company Limited) has any rights that they can enforce under this contract except for those rights that they have under road traffic law in any country in which this insurance applies.

Unless specifically agreed otherwise, this insurance shall be subject to English Law.

The terms and conditions of this policy and all other information concerning this insurance are communicated to you in the English language and we undertake to communicate in this language for the duration of the policy.



Gary Humphreys
Underwriting Director
Markerstudy Insurance Company Limited
and/or its co-Insurers whose names and
addresses are available upon request.

Authorised Insurers, registered in Gibraltar No 78789. Registered Office: 846-848, Europort, Gibraltar.

Markerstudy Insurance Company Limited is regulated by the Gibraltar Financial Services Commission and subject to a limited regulation by the Financial Services Authority in respect of underwriting insurance business in the UK (FSA Number 206322).

Markerstudy Insurance Company Limited is a member of the Association of British Insurers.

Several Liabilities Notice

The obligations of Markerstudy Insurance Company Limited and its co-insurers under contracts of insurance to which they subscribe are several and not joint and are limited solely to the extent of each insurer's individual subscription. If one of the insurers does not for any reason satisfy all or part of its obligations the other insurers will not be responsible for the defaulting insurer's obligations.

The Financial Services Compensation Scheme covers this policy. You may be entitled to compensation from this scheme if we cannot meet our liabilities under this policy. Further information about compensation scheme arrangements is available at www.fscs.org.uk or by telephoning 0207 892 7300.

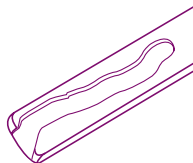

Definitions

The words or phrases shown below have the same meaning whenever they appear in this policy document or in the Certificate of Motor Insurance, Policy Schedule or Endorsements. So that you can easily identify these words and phrases they are shown in bold print throughout this policy document.

Approved Repairer

A motor vehicle repairer authorised by **us** or **our** representative to repair the **insured vehicle** following a valid claim under Section A or Section B of this insurance.

Certificate of Motor Insurance

A document, which is legal evidence of **your** insurance and is required by law and forms part of this contract of insurance. It shows the **insured vehicle's** registration number, who may drive it and what it may be used for. The **Certificate of Motor Insurance** must be read with this policy document.

Courtesy Car

A car loaned to **you** by **our approved repairer** whilst the **insured vehicle** is being repaired following a valid claim under Section A or Section B of this insurance.

Endorsements

A change in terms of this insurance, which replaces or alters the standard insurance wording.

Excess

An amount **you** have to pay towards the cost of a claim under this insurance. **You** have to pay this amount regardless of the circumstances leading to the claim.

Geographical Limits

The United Kingdom of Great Britain & Northern Ireland, the Isle of Man and the Channel Islands.

Insurance Intermediary

The intermediary who has placed this insurance with **us**, acting on **your** behalf as your agent and through whom all matters concerning this insurance are handled.

Insured Vehicle

The motor car, the details and registration number of which are shown in the **Policy Schedule**. Permanently fitted accessories (other than **in-car entertainment, communication and navigation equipment**) are included within this definition.

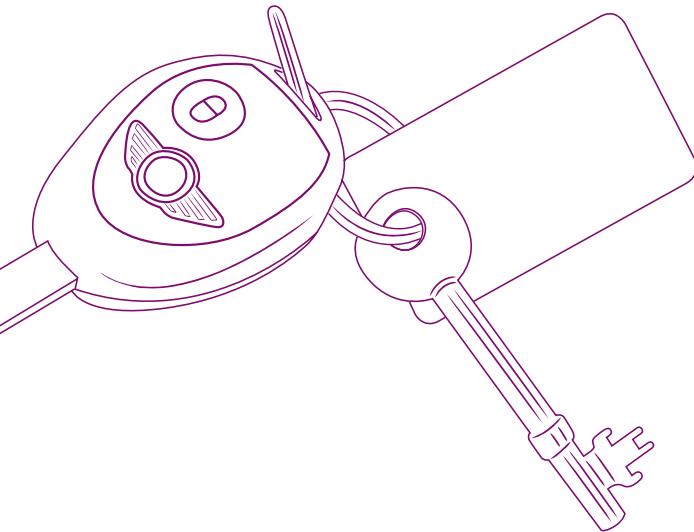

Definitions (continued)

7

In-car Entertainment, Communication and Navigation Equipment

Permanently fitted radios, cassette, compact disc or DVD players, telephones, CB radios and visual navigation equipment. Portable items (such as radar detection equipment, personal digital assistants or portable GPS navigators), cassette tapes, compact discs or DVDs are not included within this definition.

Market Value

The value of the **insured vehicle** at the time of loss or damage compared with one of the same make, model, specification and condition. If the **insured vehicle** was first registered as new in a country other than the United Kingdom any assessment of **market value** will take into account that the car has been individually imported into the United Kingdom but will not include any delivery costs incurred at the time of importation. The **market value** will be assessed by an automotive engineer in conjunction with the published trade guides at the time of loss.

Period of Insurance

The period between the effective date and expiry date shown on the **Policy Schedule** and any subsequent period for which **we** accept renewal of the insurance.

Policy Schedule

The document which shows details of the insured policyholder and insurance protection provided and forms part of this contract of insurance.

Proposal Form

The application for insurance and declaration completed by **you** or on **your** behalf. **We** have relied on the information provided on this form in entering into this contract of insurance.

Statement of Fact or Statement of Insurance

The form that shows the information that **you** gave **us** or that was given on **your** behalf at the time **you** applied for insurance. **We** have relied on the information provided on this form in entering into this contract of insurance.

Terrorism

Terrorism as defined in the Terrorism Act 2000.

We/Us/Our

Markerstudy Insurance Company Limited and/or its co-insurers whose names and addresses are available upon request.

You/Your

The insured policyholder named in the **Policy Schedule** or **Certificate of Motor Insurance**.

Insurance Provided - Guide to Policy Cover

The level of cover provided by this insurance is shown on **your Policy Schedule**. The sections of this Private Car Insurance Policy that apply for each level of cover are as shown below. Cover is subject to any **endorsement** shown on **your Policy Schedule**.

Comprehensive

Sections A to K of this Private Car Insurance Policy apply.*

Third Party Fire and Theft

Sections B, C, J, and K of this Private Car Insurance Policy apply.*

Third Party Only

Sections C, J, and K of this Private Car Insurance Policy apply.*

The General Exceptions and General Conditions of this Private Car Insurance Policy apply to all levels of cover.

* Section L may also apply if shown on your **Policy Schedule**.

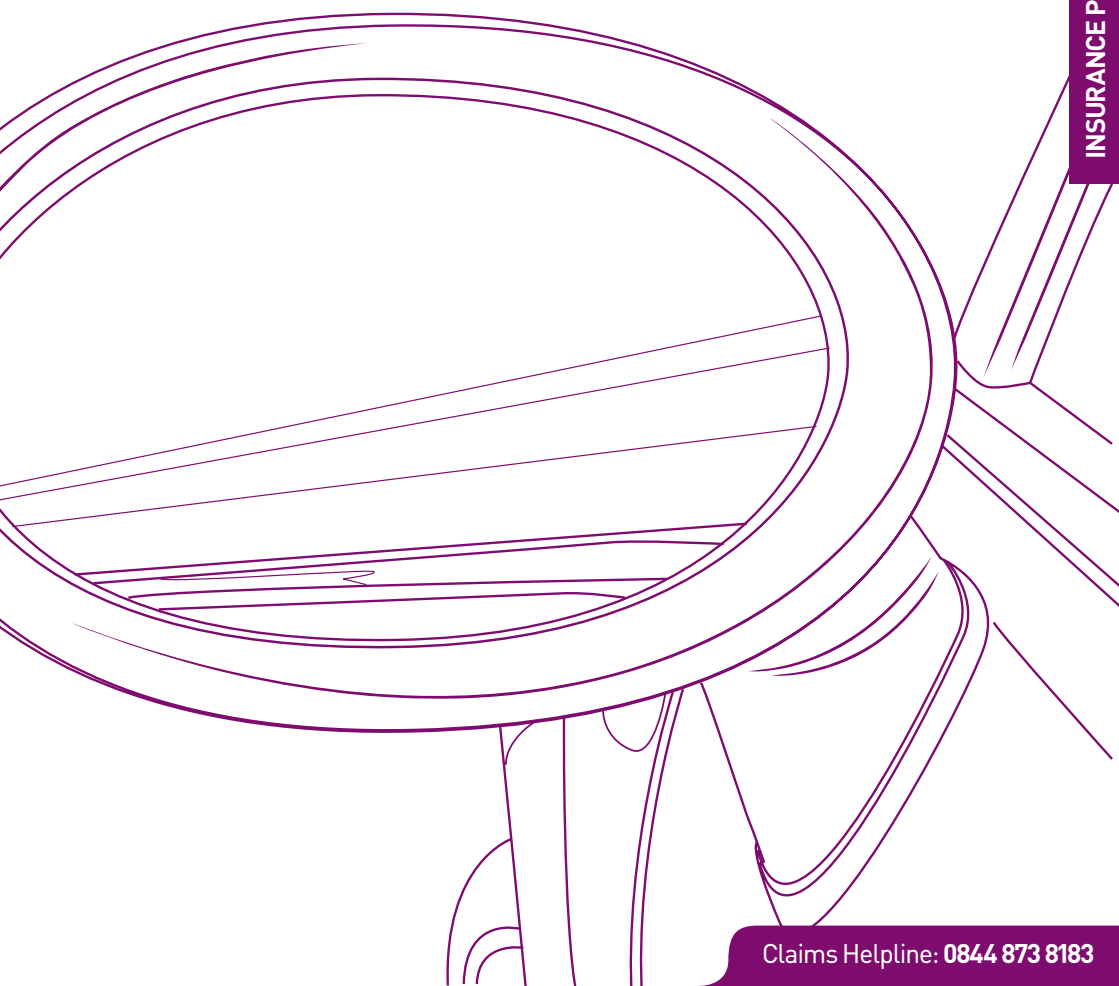

Section A - Loss of or Damage to the Insured Vehicle

This section only applies if the cover shown on your **Policy Schedule** is Comprehensive.

What is covered

We will cover **you** against loss or damage to the **insured vehicle** (less any **excess** that applies) caused accidentally or as a result of malicious damage or vandalism. Loss or damage more specifically covered under Section B of this policy is excluded.

Cover also applies under this section while the **insured vehicle** is in the custody of a member of the motor trade for servicing or repair.

Under this section we may either:

- pay for the damage to be repaired; or
- with **your** agreement provide a replacement car; or
- pay an amount of cash equivalent to the loss or damage.

The most we will pay will be either:

- the **market value** of the **insured vehicle** immediately before the loss; or
 - the cost of repairing the **insured vehicle**,
- whichever is the lower.

If the **insured vehicle** was not first registered from new in the United Kingdom **we** will not pay more than the purchase price paid by **you** at the time that **you** purchased the car.

If the **insured vehicle** is deemed to be beyond economical repair or settlement is agreed under the 'New car cover' sub-section (in adjacent column), the damaged car becomes **our** property once a claim is met under the policy. **You** must send **us** the vehicle registration document, MOT certificate and the **Certificate of Motor Insurance** for the **insured vehicle** before **we** are able to meet the claim.

If the **insured vehicle** is the subject of a Hire Purchase Agreement **we** will pay up to the amount defined above under 'the most **we** will pay'. This payment will be made to the Hire Purchase Company as owner, whose receipt shall be a discharge of any claim under this section.

In-car entertainment, communication and navigation equipment

We will pay an amount of no greater than £300 after the deduction of any **excess** that applies in respect of any one occurrence for loss of or damage caused to permanently fitted **in-car entertainment, communication and navigation equipment**.

If this equipment forms part of the original vehicle specification and was fitted by the vehicle manufacturer or their authorised dealer at the time the **insured vehicle** was first registered from new, the amount of cover for any one occurrence will be increased to a maximum of £750 after the deduction of any **excess**.

Any amount payable in respect of **in-car entertainment, communication and navigation equipment** will not exceed the value of the equipment at the time of the loss or damage after making a reasonable deduction for wear and tear.

New car cover

If the **insured vehicle** is less than one year old (calculated from the date of first registration) at the time of the incident leading to a claim under this policy, and:

- suffers damage covered by the policy; and
- is beyond economical repair

we will replace it with a new one of the same make, model and specification.

However, this new car cover only applies if:

- **you** have been the first and only registered keeper and owner; and
- a suitable replacement car is available in the United Kingdom; and
- anyone else who has an interest in the **insured vehicle** agrees; and
- the **insured vehicle** has covered less than 10,000 miles.

In the event that a vehicle of the same make, model and specification is unavailable **we** will settle the claim on the basis of the **market value** of the **insured vehicle** immediately before the loss.

Once a settlement has been agreed in accordance with this new car cover, the damaged car becomes **our** property.

If the **insured vehicle** is the subject of a Hire Purchase Agreement **we** will only agree settlement on the basis of this new car cover if **we** have the agreement of the Hire Purchase Company as owner of the **insured vehicle**.

Repairs

Repairs are normally undertaken by **our approved repairer**.

If **you** choose to use an alternative repairer:

- **you** will be responsible for paying the first £250 of each claim (in addition to any other **excess** shown elsewhere in this policy booklet or on **your Policy Schedule** or in any **endorsement**); and
- **we** will not guarantee the work after **you** have signed a customer satisfaction note and the **insured vehicle** has been returned to **you** by the repairer; and
- **we** will not pay more than the cost of repairs had the work been undertaken by **our approved repairer**. In these circumstances **we** may at **our** option settle the claim for repairs to the **insured vehicle** by making a cash payment for the amount quoted by **our approved repairer** less the **excess** which applies to the claim.

If parts required for repairing the **insured vehicle** are not available in the United Kingdom **our** liability for those parts shall not exceed the manufacturers' last United Kingdom list price or if not listed the price of those parts for the nearest comparable car available in the United Kingdom. **We** will not pay the cost of importing parts that are not available in the United Kingdom.

We may at **our** option use parts that have not been supplied by the original manufacturer to

repair the **insured vehicle**. These parts will be subject to the **approved repairer's** guarantee.

We will not pay the cost of any repair or replacement which improves the **insured vehicle** to a better condition than it was in before the loss or damage. If this does happen you must make a contribution towards the cost of repair or replacement. **You** may be required to contribute to the cost of replaced items such as exhausts or tyres.

Section A - Loss of or Damage to the Insured Vehicle (continued)

Young and Inexperienced Driver Excesses

You will be responsible for paying the following amounts while the **insured vehicle** is being driven by, is in the charge of or was last in the charge of the categories of driver listed below:

Age or experience of person driving, in charge of or last in charge of the insured vehicle	Amount of Excess
Aged 20 years and under	£300
Aged 21 to 24 years inclusive	£200
Aged 25 years and over but: <ul style="list-style-type: none">• who holds a provisional driving licence; or• who holds an international driving licence; or• has held a full driving licence to drive a private motor car issued either in a country within the geographical limits or a member country of the European Union but for less than one year.	£150

The Young and Inexperienced Driver **Excess** applicable at the time of loss or damage is determined by the age or driving experience of the person driving/in charge of the **insured vehicle** at the inception date or last renewal date of the policy whichever is the later.

The amounts shown above are in addition to any other **excesses** shown elsewhere in this policy document or on **your Policy Schedule** or in any **endorsement**.

Protection and Recovery

If the **insured vehicle** cannot be driven following an incident leading to a valid claim under this section, **we** will pay:

- the cost of its protection and removal to the nearest **approved repairer**, competent repairer or nearest place of safety; and
- the reasonable cost of re-delivery after repairs to **your** home address; and
- the cost of storage of the **insured vehicle** incurred with **our** written consent.

If the **insured vehicle** is damaged beyond economical repair we will arrange for it to be stored safely at premises of **our** choosing.

You should remove **your** personal belongings from the **insured vehicle** before it is collected from **you**.

In the event of a claim being made under the policy **we** have the right to remove the **insured vehicle** to an alternative repairer or place of safety at any time in order to keep the cost of the claim to a minimum.

Section B - Loss of or Damage to the Insured Vehicle by Fire and Theft

This section only applies if the cover shown on **your Policy Schedule** is either Comprehensive or Third Party Fire and Theft.

What is covered

We will cover **you** against loss of or damage to the **insured vehicle** (less any **excess** that applies) caused by fire (other than fire by vandalism or malicious intent), lightning, explosion, theft or attempted theft.

Cover also applies under this section while the **insured vehicle** is in the custody of a member of the motor trade for servicing or repair.

Under this section we may either:

- pay for the damage to be repaired; or
- with **your** agreement provide a replacement car; or
- pay an amount of cash equivalent to the loss or damage.

The most we will pay will be either:

- **the market value** of the **insured vehicle** immediately before the loss; or
- the cost of repairing the **insured vehicle**, whichever is the lower.

If the **insured vehicle** was not first registered from new in the United Kingdom **we** will not pay more than the purchase price paid by **you** at the time that **you** purchased the car.

If the **insured vehicle**:

- is stolen and has not been recovered at the time of settlement; or
- is deemed to be beyond economical repair,

the lost or damaged vehicle becomes **our** property once a claim is met under the policy. **You** must send **us** the vehicle registration document, MOT certificate and the **Certificate of Motor Insurance** for the **insured vehicle** before **we** are able to meet the claim.

If the **insured vehicle** is the subject of a Hire Purchase Agreement **we** will pay up to the amount defined above under 'the most **we** will pay'. This payment will be made to the Hire Purchase Company as owner, whose receipt

shall be a discharge of any claim under this section.

In-car entertainment, communication and navigation equipment

We will cover **you** for loss of or damage caused to permanently fitted **in-car entertainment, communication or navigation equipment** caused by fire (other than fire by vandalism or malicious intent), lightning, explosion, theft or attempted theft. The most **we** will pay is in accordance with the cover provided by **your** policy and is detailed below:

- Equipment forming part of the original vehicle specification and fitted by the vehicle manufacturer or their authorised dealer at the time the **insured vehicle** was first registered from new:

Cover applying to your policy	Limits Applying
Comprehensive	Up to £750 any one occurrence after the deduction of any excess
Third Party Fire & Theft	Up to £300 any one occurrence after the deduction of any excess

- Equipment not forming part of the original vehicle specification:

Cover applying to your policy	Limits Applying
Comprehensive	Up to £300 any one occurrence after the deduction of any excess
Third Party Fire & Theft	Up to £300 any one occurrence after the deduction of any excess

Any amount payable in respect of **in-car entertainment, communication and navigation equipment** will not exceed the value of the equipment at the time of the loss or damage after making a reasonable deduction for wear and tear.

Section B - Loss of or Damage to the Insured Vehicle by Fire and Theft (continued)

New car cover

If the **insured vehicle** is less than one year old (calculated from the date of first registration) at the time of the incident leading to a claim under this policy, and:

- is stolen and not recovered; or
- is beyond economical repair,

we will replace it with a new one of the same make, model and specification.

However, this new car cover only applies if:

- **you** have been the first and only registered keeper and owner; and
- a suitable replacement car is available in the United Kingdom; and
- anyone else who has an interest in the **insured vehicle** agrees; and
- the **insured vehicle** has covered less than 10,000 miles.

In the event that a vehicle of the same make, model and specification is unavailable **we** will settle the claim on the basis of the **market value** of the **insured vehicle** immediately before the loss.

Once a settlement has been agreed in accordance with this new car cover, the lost or damaged car becomes **our** property.

If the **insured vehicle** is the subject of a Hire Purchase Agreement **we** will only agree settlement on the basis of this new car cover if **we** have the agreement of the Hire Purchase Company as owner of the **insured vehicle**.

Repairs

Repairs are normally undertaken by our **approved repairer**.

If **you** choose to use an alternative repairer:

- **you** will be responsible for paying the first £250 of each claim (in addition to any other **excess** shown elsewhere in this policy booklet or on **your Policy Schedule** or in any **endorsement**); and
- **we** will not guarantee the work after **you** have signed a customer satisfaction note

and the **insured vehicle** has been returned to **you** by the repairer; and

- **we** will not pay more than the cost of repairs had the work been undertaken by our **approved repairer**. In these circumstances we may at **our** option settle the claim for repairs to the **insured vehicle** by making a cash payment for the amount quoted by our **approved repairer** less the **excess** which applies to the claim.

If parts required for repairing the **insured vehicle** are not available in the United Kingdom **our** liability for those parts shall not exceed the manufacturers' last United Kingdom list price or if not listed the price of those parts for the nearest comparable car available in the United Kingdom. **We** will not pay the cost of importing parts that are not available in the United Kingdom.

We may at **our** option use parts that have not been supplied by the original manufacturer to repair the **insured vehicle**. These parts will be subject to the **approved repairer's** guarantee.

We will not pay the cost of any repair or replacement which improves the **insured vehicle** to a better condition than it was in before the loss or damage. If this does happen **you** must make a contribution towards the cost of repair or replacement. **You** may be required to contribute to the cost of replaced items such as exhausts or tyres.

Young and Inexperienced Driver Excesses

You will be responsible for paying the following amounts in respect of any claim relating to loss of or damage caused by fire (other than by vandalism or malicious intent), lightning, explosion, theft or attempted theft while the **insured vehicle** is being driven by or is in the charge or was last in the charge of the categories of driver listed (see page 14):

Age or experience of person driving, in charge of or last in charge of the insured vehicle	Amount of Excess
Aged 20 years and under	£300
Aged 21 to 24 years inclusive	£200
Aged 25 years and over but: <ul style="list-style-type: none"> • who holds a provisional driving licence; or • who holds an international driving licence; or • has held a full driving licence to drive a private motor car issued either in a country within the geographical limits or a member country of the European Union but for less than one year. 	£150

The Young and Inexperienced Driver **Excess** applicable at the time of loss or damage is determined by the age or driving experience of the person driving/in charge of the **insured vehicle** at the inception date or last renewal date of the policy whichever is the later.

The amounts shown above are in addition to any other **excesses** shown elsewhere in this policy document or on **your Policy Schedule** or in any **endorsement**.

Protection and Recovery

If the **insured vehicle** cannot be driven following an incident leading to a valid claim under this section, **we** will pay:

- the cost of its protection and removal to the nearest **approved repairer**, competent repairer or nearest place of safety; and
- the reasonable cost of re-delivery after repairs to **your** home address; and
- the cost of storage of the **insured vehicle** incurred with **our** written consent.

If the **insured vehicle** is damaged beyond economical repair **we** will arrange for it to be stored safely at premises of **our** choosing.

You should remove **your** personal belongings from the **insured vehicle** before it is collected from you.

In the event of a claim being made under the policy **we** have the right to remove the **insured vehicle** to an alternative repairer or place of safety at any time in order to keep the cost of the claim to a minimum.

Guidance Notes - Preventing Crime

- Don't give criminals an easy ride. Car crime makes up 20% of all recorded crimes in the UK.
- Most thefts can be prevented - and it's in your interest and ours to take some simple precautions. Most things are common sense.
- Lock your car and remove your ignition key/locking device when leaving it for even a short time e.g. at a petrol station or cashpoint.
- Vehicle thieves often steal the keys first especially if the vehicle has an immobiliser and break into houses just to access keys to steal the car. Always keep keys secure even inside your home (do not leave keys where a burglar can easily find them such as on a shelf or hook).
- Keys and locking devices should always be kept in a safe and secure place - do not leave them on a wall hook, windowsill or in a jacket pocket next to the vehicle.
- Take appropriate measures to safeguard the vehicle when showing it to prospective purchasers.
- Do not keep items such as the car registration document, service book, MOT certificate or insurance certificate in the car and never leave any valuables on view in the car. You should remove items such as CD players, Radios/MP3 players and portable satellite navigation equipment whenever possible.
- Use good-quality locks and security devices.
- Park in a secure place if you can. If you have a garage, use it and lock it.

Exceptions to Sections A & B

What is not covered

These sections of **your** insurance policy do not cover the following:

- The amount of any **excess** shown in the **Policy Schedule** or in this policy document or in any **endorsement** that applies.
- Indirect losses which result from the incident that caused **you** to claim, for example, **we** will not pay compensation for **you** not being able to use the **insured vehicle**.
- Wear and tear, mechanical or electrical breakdown including failure of any equipment, integrated circuit, computer chip, computer software or computer related equipment and failure or breakages of any part due to application of brakes or road shocks.
- Depreciation or loss of value following repairs.
- Loss of or damage to the **insured vehicle** arising from the vehicle being taken by a person:
 1. who is not permitted to drive under the **Certificate of Motor Insurance** or is excluded by **endorsement**; and
 2. who is also **your** employee or a member of **your** family or household or in a close personal relationship with **you** or a member of **your** family or household.
- Loss suffered due to any person obtaining any property by fraud or deception, for example a purchaser's cheque not being honoured by their bank.
- Loss or damage to the **insured vehicle** where possession of it is gained by deception on the part of someone pretending to be a buyer or someone pretending to act on behalf of a buyer.
- Loss or damage caused by pressure waves from aircraft or any flying object.
- Loss of or damage to keys, lock or ignition activators, alarm or immobiliser activators (except as insured under Section I of this insurance - Replacement Locks).
- Repairs, re-programming or replacement of any component, including locks on the **insured vehicle**, resulting from the loss of or damage to the car's keys, lock or ignition activators or alarm or immobiliser activators (except as insured under Section I of this insurance - Replacement Locks).
- Loss of or damage to the **insured vehicle** and/or **in-car entertainment, communication and navigation equipment** while **you** are not in the car arising from theft or attempted theft when:
 1. ignition keys have been left in or on the **insured vehicle**; or
 2. the **insured vehicle** has not been secured by means of door and boot lock; or
 3. any window or any form of sliding or removable roof or hood have been left open or unlocked; or
 4. the **insured vehicle** is fitted with a manufacturer's standard security device and the device is not operational or is not in use.
- Loss or damage caused by an inappropriate type or grade of fuel being used.
- Confiscation, requisition or destruction by or under the order of any Government or Public or Local Authority.
- Damage to tyres caused by braking, punctures, cuts or bursts.
- Loss or damage caused deliberately by **you** or by any person who is driving the **insured vehicle** with **your** permission.

Section C - Liability to Other People

What is covered

Use of the insured vehicle

We will cover the categories of people listed below for their legal liability for death, bodily injury or damage to property arising out of the use of the **insured vehicle** or an attached trailer or caravan:

- **You**; and
- any person permitted to drive the **insured vehicle** under the **Certificate of Motor Insurance** who is driving with **your** permission; and
- any passenger in the **insured vehicle**; and
- any person using (but not driving) the **insured vehicle** for social domestic and pleasure purposes with **your** permission; and
- the employer or business partner of any person named as a permitted driver on **your Certificate of Motor Insurance** in the event of an accident occurring while the **insured vehicle** is being used for business by that named person as long as **your Certificate of Motor Insurance** allows business use by such person; and
- the legal representatives of any person who would have been covered under this section.

Third Party Property Damage Limit

The most **we** will pay for property damage for any one claim, or series of claims arising out of any one event is £20,000,000. The most **we** will pay in costs for any one property damage claim or series of property damage claims arising out of any one event is £5,000,000.

Legal Costs

If there is an accident that is covered under this insurance **we** may at our absolute discretion consider payment in respect of the following legal costs:

- solicitors fees for representing **you** at any fatal accident enquiry, Coroner's, Magistrates or similar court; and

- the reasonable cost of legal services to defend **you** against a charge of manslaughter or causing death by dangerous or reckless driving.

If **we** agree to pay these costs under this policy the choice and appointment of legal representation and the extent of any assistance that **we** provide will be entirely at **our** discretion. There will be no agreement to pay these costs unless **we** have confirmed this to **you** in writing.

Driving Other Cars

We will provide cover under this section (but only if stated in **your Certificate of Motor Insurance**) while **you** are driving with the owner's consent, any private motor car which is not owned by **you** or hired to **you** under a hire purchase agreement, provided that **you** are not covered by any other insurance and the car **you** are driving is in a roadworthy condition.

Driving Other Cars cover cannot be used to obtain the release of cars which have been seized by, or on behalf of, any government or public authority.

Additionally Driving Other Cars cover will not operate:

- if the policy is issued in the name of a company or firm; or
- if the **insured vehicle** is sold or disposed of, or declared a total loss; or
- if the car you are driving is owned by or provided by an employer or business partner; or
- outside the **geographical limits** of this policy.

Emergency Medical Treatment

We will pay emergency treatment charges required by the Road Traffic Acts. If this is the only payment **we** make, it will not affect **your** No Claim Discount.

Exceptions to Section C

What is not covered

We shall not be liable:

- if the person claiming is otherwise insured; or
- for loss or damage to property belonging to or in the care of any person insured under this section or for not being able to use any such property; or
- for damage to the **insured vehicle** or property in it or being conveyed in it or for not being able to use any such property; or
- for loss or damage to any trailer or caravan being towed by the **insured vehicle** or for not being able to use any such trailer or caravan; or
- if the death of or bodily injury to any person covered under this section arises out of or in the course of his/her employment except where such liability must be covered under the Road Traffic Acts; or
- for death or bodily injury to any person being carried in or on any trailer or caravan; or
- if a person who was not driving makes a claim and he/she knew that the person driving did not hold a valid driving licence.

Section D - Provision of a Courtesy Car

This section applies only if the cover shown on **your Policy Schedule** is Comprehensive.

What is covered

If a valid claim is made under this policy, and the **insured vehicle** is to be repaired by one of our **approved repairers**, the repairer will provide **you** with a **courtesy car** (subject to availability) for the duration of the repairs.

If the parts required to repair the **insured vehicle** are not immediately available to our **approved repairer** we reserve the right to withhold the provision of a **courtesy car** until such time as the necessary parts are available and repair work can proceed.

If the **insured vehicle** is accepted by our **approved repairer** as being a repairable proposition, but it is subsequently deemed by us to be beyond economical repair, we reserve the right to withdraw the **courtesy car** immediately.

The **courtesy car** can only be provided subject to availability and will be supplied subject to our **approved repairer's** standard terms and conditions, for use in the United Kingdom only. Our aim is to keep **you** mobile rather than the **courtesy car** being a replacement for the **insured vehicle** in terms of status or performance. The **courtesy car** will normally be a small hatchback of less than 1200cc.

While **you** are in possession of the **courtesy car**, cover for loss of or damage to the car will be provided by this policy in accordance with its terms, **endorsements** and conditions, including **excesses** for which **you** will be responsible. **We** will not make a charge for this cover.

Any accidents or losses while **you** are in possession of the **courtesy car** must be reported to **us** immediately, and may affect **your** No Claim Discount.

Driving of the **courtesy car** will be limited solely to those persons named on **your Certificate of Motor Insurance**, and the use of the car will be restricted to the use described on that certificate.

You are not required to inform **us** when **you** are supplied with a **courtesy car** from our **approved repairer**.

You must return the **courtesy car** to our **approved repairer** either when we ask **you** to do so or if this insurance falls due for renewal and **you** fail to renew it with **us**.

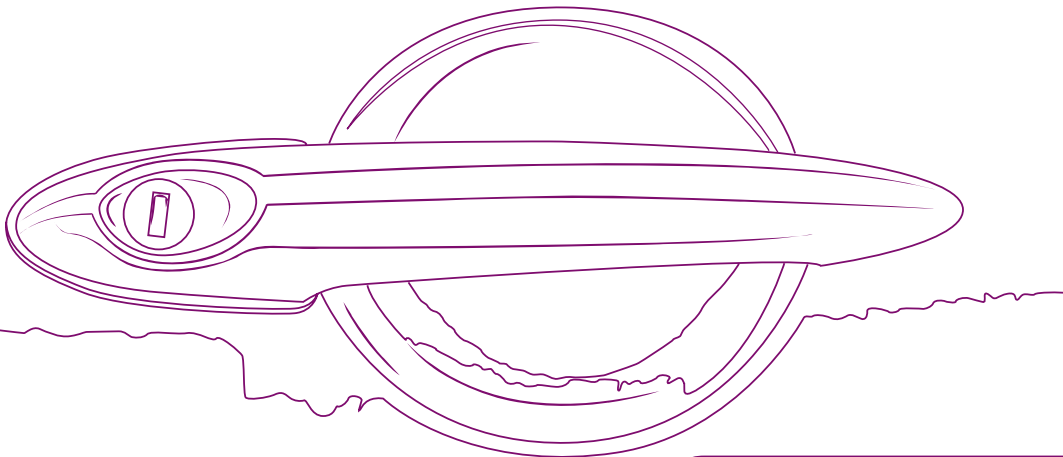

Section E - Personal Accident Benefits

This section applies only if the cover shown on **your Policy Schedule** is Comprehensive.

What is covered

We will pay the following amounts for each person if **you, your** legally married spouse or civil partner accidentally receives an injury as detailed below. Payment will only be made if the injury, independently of any other cause, and within 3 months of the accident results in:

Death	£5,000
Complete and permanent loss of sight of one or both eyes	£2,000
Complete and permanent loss of one or more limbs	£2,000

Payment will only be made where the injury or death directly results from an accident while getting into, out of or travelling in the **insured vehicle** (or any other private motor car which **you** do not own).

We will make payment to **you or your** legal representatives. Payment made under this section will be limited to a maximum amount of £5,000 in any one year of insurance regardless of the number of persons injured or the types of injury sustained.

What is not covered

This personal accident benefit does not apply:

- to policies issued in the name of a company or firm; or
- where death or bodily injury is caused by suicide or attempted suicide, natural disease or pre-existing physical defect; or
- in respect of death of or bodily injury to the driver at the time of the accident if such person was convicted for driving under the influence of drugs or alcohol at the time of the accident; or
- for death or bodily injury to any person in the **insured vehicle** if such person had not complied with the law relating to the use of seat belts.

Section F - Personal Belongings

This section applies only if the cover shown on **your Policy Schedule** is Comprehensive.

What is covered

We will pay a total amount no greater than £100 for personal belongings while in the **insured vehicle**, if they are lost or damaged because of any accident, fire, theft or attempted theft or by malicious means.

What is not covered

Personal belongings cover does not apply:

- to policies issued in the name of a company or firm; or
- to money, stamps, tickets or securities; or
- to jewellery or furs; or
- to radar detection equipment; or
- to goods or samples, tools or equipment connected with any trade or business; or
- in respect of theft of property from the **insured vehicle** if:
 1. ignition keys have been left in or on the **insured vehicle**; or
 2. the **insured vehicle** has not been secured by means of door and boot lock; or
 3. any window or any form of sliding or removable roof or hood have been left open or unlocked; or
 4. the **insured vehicle** is fitted with a manufacturer's standard security device and the device is not operational or is not in use.
- in respect of theft of property from an open-topped or convertible car unless the property was being kept in a locked boot or locked glove compartment; or
- in respect of any permanently fitted audio, navigation or telephone equipment (except as insured under Section A or Section B of this insurance).

Section G - Medical Expenses

This section applies only if the cover shown on **your Policy Schedule** is Comprehensive.

What is covered

We will pay up to £200 per person for medical expenses for anyone who is injured while they are in the **insured vehicle**.

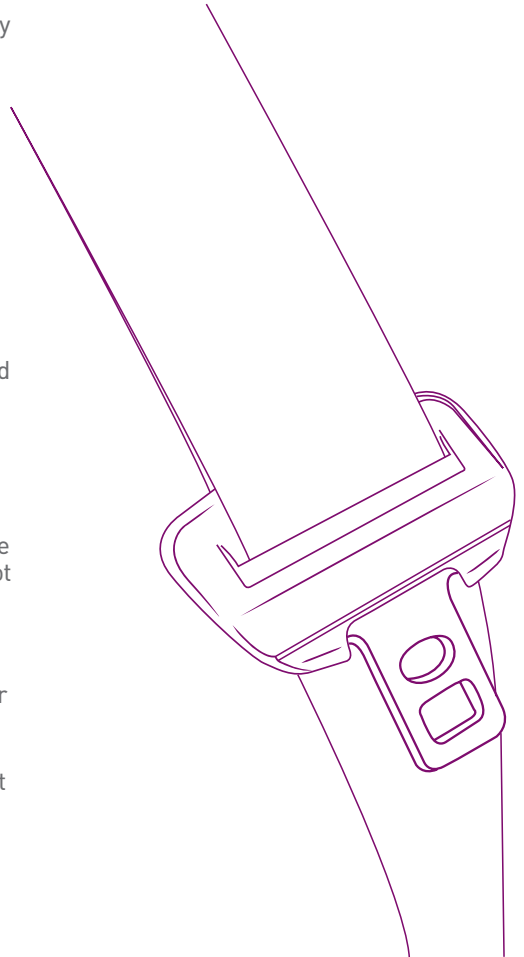

Section H - Glass Damage

This section applies only if the cover shown on **your Policy Schedule** is Comprehensive.

What is covered

We will pay the cost of repair/replacement of broken glass windscreens or glass windows, without loss of No Claim Discount providing the work is carried out by **our** approved replacement service.

We may at **our** option use parts that have not been supplied by the original manufacturer. If you insist that **we** use parts supplied by the original manufacturer even though alternative non-original manufacturer parts are available **you** will be required to pay **us** any difference in the cost of such parts.

If an incident occurs involving the breakage of multiple items of glass **we** will only pay for one piece of glass under this extra benefit.

In the event of an incident likely to give rise to a claim for damaged glass please call our **24 hour Claims Helpline on 0844 873 8183**.

If **you** do not use **our** approved replacement service cover is limited to an amount of £75 (after the deduction of any **excess** that applies) in any one annual **period of insurance**, without loss of No Claim Discount.

What is not covered

- **You** will be required to pay the first £80 of each claim under this section in respect of a replacement windscreen or window. Where the windscreen or window can be repaired and does not require replacement, any claim for repair will be subject to an **excess** of £25.
- **We** will not pay claims for mechanical items associated with the window mechanisms of the **insured vehicle** under this section.
- **We** will not pay the cost of importing parts or items of replacement glass that are not available in the United Kingdom.
- **We** will not pay claims for the repair or replacement of sunroofs, glass roofs, panoramic windscreens, lights/reflectors

or folding rear windscreen assemblies under this section.

- Loss or damage caused deliberately by **you**.

Section I - Replacement Locks

This section applies only if the cover shown on **your Policy Schedule** is Comprehensive.

What is covered

In the event that:

- one or more of the keys or lock transmitters or entry cards for a keyless entry system for the **insured vehicle** is stolen; and
- it can be established that the identity or garaging address of the **insured vehicle** is known to any person who may have **your** keys or transmitter or entry card,

we will pay an amount of no greater than £300 for any one occurrence (after the deduction of the **excess** that applies to this section) towards the cost of replacing:

- the door locks and/or boot or tailgate lock; and
- the ignition/steering lock; and
- the lock transmitter and/or central locking system.

What is not covered

We will not pay:

- any claim resulting from the keys, lock transmitters or entry cards being left in or on the **insured vehicle**; or
- the first £150 of each claim under this section; or
- the cost of replacing alarms or other security devices used in connection with the **insured vehicle**

under this section of the policy.



Section J - Foreign Use of the Insured Vehicle

23

SECTION J

What is covered

Legal minimum insurance

While the **insured vehicle** is in:

- any country which is a member of the European Union (EU); or
- any other country in respect of which the European Commission is satisfied has made arrangements to meet the requirements of Article 7(2) of EU Directive 72/166/CEE relating to civil liabilities arising from the use of motor vehicles

this policy provides the minimum level of cover in respect of liability which is legally insurable in the country concerned. This legal minimum insurance does not include cover for loss of or damage to the **insured vehicle**.

Full policy cover

In addition to the legal minimum cover shown above, this policy is automatically extended to provide the cover shown in **your Policy Schedule** to any member country of the EU and also Andorra, the Channel Islands, Croatia, Gibraltar, Iceland, Liechtenstein, Monaco, Norway, San Marino and Switzerland provided that:

- **you** notify **your insurance intermediary** before **your** journey abroad; and
- the use of the **insured vehicle** abroad is limited to no more than 30 days in total in any one annual **period of insurance**; and
- **you** or any permitted driver are normally resident within the **geographical limits** of this policy; and
- **your** visit abroad is for social, domestic or pleasure purposes.

A Green Card is not required for the countries listed above and no additional premium will be payable as long as the qualifying conditions are met. Driving Other Cars cover does not apply while the **insured vehicle** is being used abroad.

If the policy is extended to provide the cover shown on **your Policy Schedule** whilst abroad:

- insurance is automatically provided on the **insured vehicle** while it is being transported (including loading and unloading) between ports in countries where you have cover, provided the **insured vehicle** is being transported by rail or a recognised sea route of not more than 65 hours; and
- **we** will pay the reasonable cost of delivery of the **insured vehicle** to **you** after repairs in the country in which damage was sustained, or to **your** home address if the damage cannot be repaired economically by the intended time of **your** return to the United Kingdom or if the car is stolen and recovered after **your** return to the United Kingdom; and
- **we** will pay the amount of foreign customs duty for which **you** are liable as a direct result of loss or damage to the **insured vehicle** preventing its return to the United Kingdom.

If **you** wish to extend full policy cover outside of the countries, scope and period limitations shown above **you** must contact **your insurance intermediary** to obtain **our** agreement to provide cover in advance of **your** intended trip abroad.

Any agreement by **us** to extend full policy cover beyond the limits above may be subject to an additional premium and policy restrictions.

The exceptions applying to sections A, B & C of this insurance also apply to this section.

Guidance Notes - Going Abroad

Restrictions do apply as far as full policy cover is concerned so, before travelling abroad, please apply to your insurance intermediary. The extended full insurance will then cover you in the countries for which we have agreed to provide cover and when your vehicle is travelling by rail or sea between those countries.

Unless you notify your insurance intermediary in advance of a trip abroad, the cover may be limited to the minimum cover you need under the law of the relevant country (EU minimum insurance). This minimum insurance will not provide any cover for damage to your car.

Take your certificate as evidence of insurance.

Important: Driving Other Cars cover does not apply abroad.

If your car suffers any loss or damage that is covered by this insurance and the car is in a

country where you have cover, we will refund any customs duty you pay to temporarily import your vehicle.

Although full policy cover abroad is automatically available for up to 30 days in any one annual period of insurance we may, on request, agree to extend cover up to a maximum of 90 days. A charge may apply. Please contact your intermediary for further information.

We will only consider extending this insurance to countries which are covered by the International Green Card system.

If you are involved in any accident or incident whilst abroad please call the 24 hour Claims Helpline using the international dialling code for the UK: **0044 844 873 8183**.

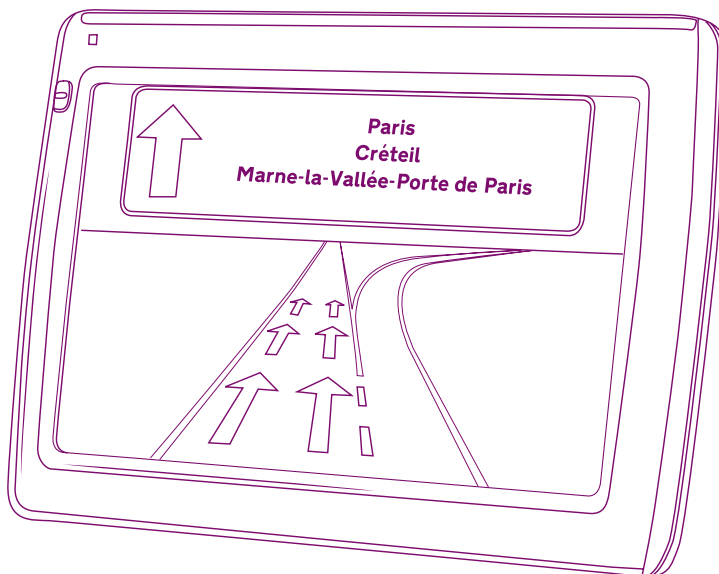

Section K - No Claim Discount

As long as no claim is made under this policy during any annual **period of insurance**, we will give **you** a discount when **you** renew **your** insurance. The discount **you** will receive will be in accordance with **our** No Claim Discount scale applicable at the time your policy is due for renewal. However, **your** entitlement will be affected in the event of a claim or multiple claims being made under this policy.

Your No Claim Discount will not be affected in the following circumstances:

- if **we** make a full recovery of all payments made by **us** in connection with the claim; or
- if **you** only claim for a broken windscreen or window under Section H of this policy and use **our** approved replacement service; or
- if **we** only have to pay for an emergency treatment fee.

If **you** make a claim or if a claim is made against **you** for an event which you may not consider to be **your** fault and **we** have to make a payment this will affect your No Claim Discount unless **we** can recover **our** outlay in full from the responsible party.

If **you** decide to cancel **your** policy and premiums remain outstanding **we** will not be able to issue proof of No Claim Discount until the outstanding premiums are paid.

You cannot transfer **your** No Claim Discount to somebody else.

Guidance Notes – No Claim Discount

There may on occasions be minor incidents (possibly involving a cyclist or pedestrian) where, although you are not claiming for damage to your vehicle, there is a potential for a claim against your policy by the third party.

In these circumstances we may disallow your No Claim Discount for up to twelve months until we are confident that a third party claim is unlikely to materialise.

Section L - Protected No Claim Discount

This section only applies if shown on **your Policy Schedule**.

The extent of No Claim Discount protection is dependent on the number of proven claim-free years earned by **you**:

If your No Claim Discount entitlement is less than four years

Dependent on the number of proven claim-free years earned by **you we** will allow a No Claim Discount entitlement in accordance with Section K of this policy.

Your No Claim Discount entitlement will not be prejudiced provided that no more than one claim is made in any one annual **period of insurance**. However, in the event of a single claim being made under this insurance in any one **annual period of insurance your** No Claim Discount:

- will not be increased at the following renewal date of the policy; and
- will only be increased at a subsequent renewal date after **you** have been insured under the policy for a further twelve months and have not made a further claim.

In the event that **you** make two or more claims in any one annual **period of insurance** your No Claim Discount entitlement will be reduced to nil at the next renewal date of the policy.

If your No Claim Discount entitlement is four or more years

You must have proved that **you** have an entitlement to at least four years' No Claim Discount.

You will not lose any of **your** No Claim Discount as long as **you** make no more than two claims in any five year **period of insurance**.

If three claims are made in any five year **period of insurance** we will reduce the discount you receive to a one year entitlement in accordance with Section K of this policy. If more than three claims are made in any five year **period of insurance we** will reduce the discount **you** receive to nil.

Regardless of the number of years No Claims Discount to which **you** are entitled **our** agreement to protect **your** No Claim Discount does not mean that the premium cannot be increased at renewal of **your** policy to reflect an adverse claims record or driving history.

General Exceptions

27

GENERAL EXCEPTIONS

These General Exceptions apply to the whole of the insurance policy.

What is not covered

1. Excluded uses and excluded drivers

We will not cover any liability, loss or damage arising while any vehicle covered by this insurance is being:

- 1.1 used for a purpose which is not permitted or is excluded by the **Certificate of Motor Insurance**; or
- 1.2 used on the Nurburgring Nordschleife or any race track, racing circuit or prepared course unless **you** have told **us** about this and **we** have agreed to provide cover; or
- 1.3 driven by, is in the charge of or was last in the charge of anyone not permitted to drive by **your Certificate of Motor Insurance** or temporary cover note or who is excluded by **endorsement**; or
- 1.4 driven by, is in the charge of or was last in the charge of anyone including you who is disqualified from driving or has never held a licence to drive a vehicle or is prevented by law from having a licence; or
- 1.5 driven by any person who holds or last held a provisional driving licence unless that person is accompanied by a full licence holder aged 21 years or over and the accompanying full licence holder has held a full driving licence for at least 3 years; or
- 1.6 driven by, is in the charge of or was last in the charge of any person who does not meet the terms or conditions of his/her driving licence; or
- 1.7 used in an unsafe condition or while carrying an insecure load or while carrying a number of passengers that is likely to affect the safe driving of the vehicle; or
- 1.8 driven by **you** or any person insured to drive, should it be proved to **our** satisfaction that the driver was under the influence of alcohol or drugs at the time of such loss or damage occurring. A conviction under the relevant law

(including a conviction for failing to supply a specimen of breath, blood or urine) shall be deemed to be conclusive evidence that the driver at the time of the loss or damage was under the influence of alcohol or drugs.

General Exception 1 will not apply:

- if the **insured vehicle** has been stolen or taken away without **your** permission; or
- if the **insured vehicle** is in custody of a garage for repair or servicing; or
- under General Exception 1.1 only, while the **insured vehicle** is being used for car sharing purposes as defined in General Condition 9 of this policy.

2. Overseas use

We will not make any payments for any liability loss or damage that occurs outside of the **geographical limits** of this policy unless extended under the terms of Section J - Foreign Use (apart from the minimum cover required by law).

Additionally **we** will not make any payments in respect of any proceedings brought against **you** or judgement passed in any court outside of the **geographical limits**, unless the proceedings or judgement arise out of the **insured vehicle** being used in a foreign country which we have agreed to extend this insurance to cover and the proceedings or judgement are brought in such country.

3. Contractual liability

We will not cover any liability **you** have accepted under an agreement or contract unless **you** would have had that liability anyway.

4. Radioactivity

We will not cover any legal liability of whatsoever nature directly or indirectly caused by or contributed to or arising from:

- ionising radiations or contamination by radioactivity from any irradiated nuclear fuel or from any nuclear waste from the combustion of nuclear fuel; or

- the radioactive toxic explosive or other hazardous properties of any explosive nuclear assembly or nuclear component.

5. War

We will not pay for any loss damage or liability arising as a consequence of war invasion or act of foreign enemy, hostilities (whether war be declared or not), civil war, rebellion, revolution, insurrection or military or usurped power.

6. Earthquake, riot and civil commotion

We will not pay for death, bodily injury, loss, damage and/or liability arising during (unless **you** prove that it was not occasioned thereby) or in consequence of:

- earthquake; or
- riot or civil commotion occurring elsewhere than in Great Britain, the Isle of Man or the Channel Islands.

7. Use on airfields

We will not cover any liability in respect of:

- any accident, loss or damage to any aircraft; or
- death or bodily injury arising in connection with any accident loss or damage to any aircraft; or
- any other loss indirectly caused by such accident loss or damage to any aircraft

incurred, caused or sustained while any vehicle covered by this insurance is in or on any airport or airfield.

8. Pollution

We will not pay for any liability, loss or damage resulting from pollution or contamination however caused, other than as required by the law of any country in which **we** have agreed to provide cover under this policy.

9. Terrorism

We will not cover any liability loss or damage caused by acts of **terrorism** apart from the minimum level of cover **we** must provide by law.

General Conditions

These General Conditions apply to the whole of the insurance policy.

1. Payment of premium, keeping to the policy terms and duty of disclosure

We will only provide the cover described in this insurance policy if:

- **you** have paid or agreed to pay the premium for the current **period of insurance**; and
- **you** or any person claiming protection has kept to all of the terms and conditions of this policy (including those applied by **Endorsement**) as far as they can apply; and
- the information **you** gave on **your proposal form** and declaration or **statement of fact** or **statement of insurance** is, to the best of **your** knowledge and belief, correct and complete.

Your premium is based on information **you** supplied at the start of the insurance, subsequent alteration or renewal. **You** must tell **us** via **your insurance intermediary** immediately of any change to that information, some examples are any changes to the **insured vehicle** which improve its value, attractiveness to thieves, performance or handling, any change of car, change of occupation (including part-time), change of address (including where car is kept), change of drivers, if **you** or any drivers pass your driving test or sustain a motoring or non-motoring conviction or fixed penalty endorsement or there is a change of main driver.

If **your** premium has been calculated on a limited annual mileage basis **we** will seek evidence at the time of a claim to prove that **your** estimated annual mileage has not been exceeded. If **you** fail to supply appropriate evidence or evidence is provided by you which shows that the estimated annual mileage has been exceeded **you** will be required to pay the additional amount of **excess** shown on the **endorsement** applying to **your** policy.

If **you** or anyone acting on **your** behalf knowingly commit a fraudulent act or submit a fraudulent document or make a fraudulent

statement or exaggerate **your** claim, **we** will not pay the claim and cover under this insurance will cease immediately. **You** will not be entitled to any refund of premium.

2. Looking after your car

You or any permitted drivers are required to maintain the **insured vehicle** in a roadworthy condition. **You** or any person in charge of the **insured vehicle** are required to take all reasonable care to safeguard it and its contents from loss or damage, for example the car should not be left unlocked.

We shall at all times be allowed free access to examine the **insured vehicle**.

3. Having an MOT certificate

There must be a valid Department for Transport test certificate (MOT) in force for the **insured vehicle** if one is needed by law. In the absence of a valid Department for Transport test certificate (MOT) all cover under sections A and B of this insurance is cancelled and of no effect.

4. Accidents or losses

In the event of an accident or incident likely to give rise to a claim which is covered under the policy, **you** must as soon as possible telephone **our 24 hour Claims Helpline (this must be within 24 hours of the incident occurring)**. **Please also refer to Page 4 of this policy booklet 'What to do in the Event of an Accident' for further guidance.**

If the loss or damage is covered under the policy, the Claims Helpline operator will make arrangements to remove the **insured vehicle** to the nearest **approved repairer**, competent repairer or place of safety, and safeguard the **insured vehicle** and its contents.

We will not pay for further damage to the **insured vehicle** if **you** drive it or attempt to drive it in a damaged condition.

If **your** claim is due to theft, attempted theft, malicious damage or vandalism, **you** must also notify the police and obtain a crime report number.

We have the right to remove the **insured vehicle** at any time to keep claims costs to a minimum. If the **insured vehicle** is damaged beyond economical repair **we** will arrange for it to be stored safely at premises of **our** choosing.

If **we** ask to examine driving licences and vehicle documentation before agreeing to settle a claim under this policy **you** must supply this documentation before **we** can proceed with the settlement.

Any indication of a claim against **you** must be notified to **us** as soon as possible. Any writ, or notification of civil or criminal proceedings should be sent to **us** by recorded delivery immediately.

We shall be entitled to take over and conduct the defence or settlement of any claim or prosecute any claim in the name of any person covered by this insurance.

5. Claims procedures

No admission of liability, payment or promise of payment shall be made or given by **you** or any person on **your** behalf. No proceedings may be commenced against, or settlement accepted from, any other party without our written consent.

We shall have discretion in the conduct of any proceedings or in the settlement of any claim.

You must give **us** whatever co-operation, information and assistance **we** require in dealing with any claim under this policy.

If there is any other insurance in force which covers the same loss, damage or liability as this insurance, **we** will only pay our proportionate share of the claim.

6. Cancellation

Cancelling the policy within the reflection period

This insurance provides **you** with a reflection period to decide whether **you** wish to continue with the full policy. The reflection period is for 14 days from the date **you** receive **your** policy documentation.

If a period of less than 14 days has elapsed since **you** received **your** policy documentation, and **you** have not made a total loss claim, **you** have the right to cancel the policy and receive a refund of premium. **You** must return **your Certificate of Motor Insurance** or provide **us** with an electronic declaration of surrender in accordance with Section 147 of the Road Traffic Act 1988 before **we** can proceed with the cancellation.

- If at the date of cancellation **your** policy has not yet commenced **you** will receive a full refund from **us**; or
- If **your** policy has already commenced, **you** will receive a full refund from **us**, less a pro rata charge for the period of cover provided. An administration charge which will be no less than £25 will also apply.

Cancelling the policy after the reflection period

Cancellation by Us

We or **your Insurance Intermediary** can cancel this policy by giving **you** 7 days' notice in writing to **your** last address notified to **us**. **You** must return your current **Certificate of Motor Insurance** to **us** or provide **us** with an electronic declaration of surrender within 7 days to comply with Section 147 of the Road Traffic Act 1988. When **we** have received the **Certificate of Motor Insurance** or the electronic declaration of surrender **we** will refund the premium relating to the remaining **period of insurance** on a pro rata basis.

Non-payment of premium

When cancellation follows **your** failure to pay the full premium, the amount of money to be returned to **you** will be calculated taking into account our short-period scale of charges. There will be no refund of premium allowable if there has been a loss or incident likely to give rise to a claim during the current **period of insurance**. **We** may at **our** discretion reduce any claims payment by the amount of outstanding or overdue premiums that **you** owe **us**.

General Conditions (continued)

Cancellation by you

You or your **Insurance Intermediary** can cancel this policy by giving **us** 7 days' notice in writing and either returning your **Certificate of Motor Insurance** or providing **us** with an electronic declaration of surrender in accordance with Section 147 of the Road Traffic Act 1988. Providing there have been no claims in the current **period of insurance** we will refund the premium relating to the number of months remaining during the current **period of insurance** from the date of receipt of your **Certificate of Motor Insurance** or electronic declaration of surrender taking into account our short-period scale of charges.

Short-period scale of charges

The following scale of charges will be used to calculate any refund of premium due to **you** following your non-payment of the full premium or following a decision by **you** to cancel this policy:

Length of time cover in force	Percentage of premium payable
Up to 1 month	25%
Up to 2 months	40%
Up to 3 months	50%
Up to 4 months	65%
Up to 5 months	70%
Up to 6 months	75%
Up to 7 months	90%
Up to 8 months	90%
Over 8 months	100%

Guidance Notes - Policy Cancellation

Please note that any refund from us whether during or after the reflection period may be subject to a further cancellation charge levied by your insurance intermediary. Any charges levied by your insurance intermediary will be in accordance with the terms and conditions agreed between you and them at the time you arranged this insurance.

In all circumstances the Certificate of Motor Insurance or an electronic declaration of surrender must be submitted to us when a policy is cancelled. Failure to return the Certificate of Motor Insurance or forward an electronic declaration of surrender is an offence under the Road Traffic Act and a prosecution may result.

The policy can only be cancelled from the date the Certificate of Motor Insurance or electronic declaration of surrender is received by us.

7. Total losses

If as a result of a claim the **insured vehicle** is determined to be a total loss this policy will cease without refund of premium unless **you** change your vehicle to another that would normally be acceptable to **us**. In the event of the policy ceasing due to the **insured vehicle** being a total loss, and there being no replacement vehicle to insure or if there is a replacement vehicle to insure which is unacceptable to **us**, all outstanding or overdue premiums must be paid immediately. **We** may at our discretion reduce the claims payment by the amount of outstanding or overdue premiums that **you** owe **us**.

8. Right of recovery

If under the laws of any country in which this insurance applies, **we** have to make payments which but for those laws would not be covered by this policy, **you** must repay the amounts to **us**.

You or the person who caused the accident must also repay **us** any money **we** have to pay because of any agreement **we** have with the Motor Insurers' Bureau.

Any payment **we** have to make because **we** are required to do so by compulsory insurance law or an agreement with the Motor Insurers' Bureau will prejudice **your** No Claim Discount and will also mean that there will be no entitlement to a return of premium if the policy is cancelled or declared void.

9. Car sharing

This policy allows **you** to carry passengers for social or similar purposes and **your** receipt of a mileage allowance or a payment by a passenger towards the cost of fuel will not invalidate cover as long as:

- **you** do not make a profit from the car sharing arrangement; and
- **your** car is not adapted to carry more than eight people (including the driver); and
- **you** are not carrying passengers as customers of a passenger-carrying business.

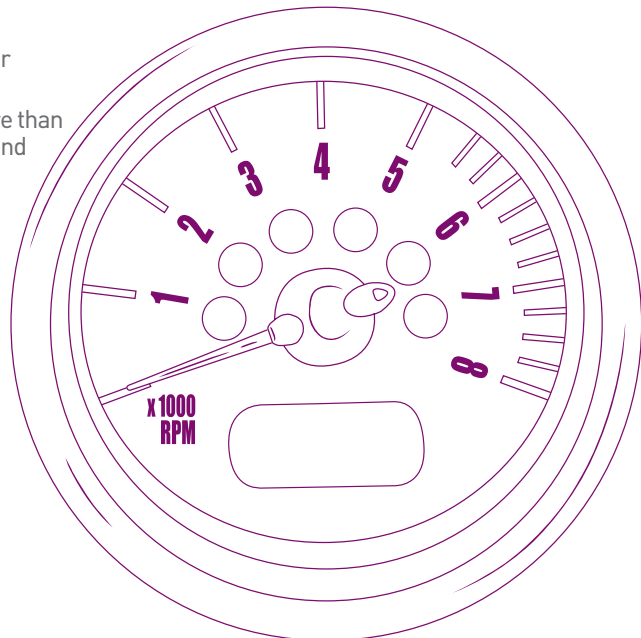

Endorsements

These endorsements do not apply to **your** insurance unless shown on **your Policy Schedule** for the current **period of insurance**.

Endorsement E004: Value-related excess

If the **insured vehicle** is declared a total loss following a valid claim under this insurance, an **excess** calculated at 10% of the vehicle's **market value** at the time of the loss will apply.

This **excess** is in addition to any other **excess(es)** shown in this policy document or on **your Policy Schedule** or in any other **endorsement**.

Endorsement E007: Excluding drivers under 21 years of age

There is no cover under this policy whilst the **insured vehicle** is being driven by or is in the charge of any person under twenty-one years of age.

Endorsement E008: Excluding drivers under 25 years of age

There is no cover under this policy whilst the **insured vehicle** is being driven by or is in the charge of any person under twenty-five years of age.

Endorsement E009: Excluding drivers under 30 years of age

There is no cover under this policy whilst the **insured vehicle** is being driven by or is in the charge of any person under thirty years of age.

Endorsement E030: Noted owner endorsement

It is noted that the **insured vehicle** is not owned and/or registered by the **Insured**.

Endorsement E038: Vehicle tracking device

It is a condition of this insurance that an approved tracking device is fitted to the **insured vehicle** and that it is operative when you are not in the **insured vehicle**.

In the absence of an operative approved tracking device when **you** are not in the **insured vehicle** all theft cover under this policy is inoperative.

Endorsement E067: Limited annual mileage

Your premium is based on a restricted annual mileage of 6,000 miles. If **you** exceed this limit within a twelve month period, your policy may be invalidated and in the event of a claim cover would be inoperative.

Endorsement E068: Declared annual mileage

Your premium is based on the vehicle's annual mileage, as declared to **your insurance intermediary** at the inception of this policy. If **you** exceed this limit within a twelve month period, **your** policy may be invalidated and in the event of a claim cover would be inoperative.

Endorsement E117: Excluding theft when not garaged

Theft cover is excluded in the event of the **insured vehicle** not being kept in a locked garage between the hours of 10pm and 6am whilst parked at **your** home address as last notified to us.

Endorsement E555: Cover excluded for in-car entertainment, communication and navigation equipment

We will not be liable for loss of or damage to any **in-car entertainment, communication and navigation equipment** which is fitted to the **insured vehicle**.

Endorsement E556: Bound by last proposal form/statement of fact

This contract of insurance has been granted on the basis of the information contained in the last completed **proposal form, statement of fact or statement of insurance** together with any material changes notified to us or **your insurance intermediary**. In accordance with General Condition 1 of this policy, **your** failure to notify **us** or **your insurance intermediary** of any material changes could invalidate your insurance.

Endorsement E654: Excluding drivers under 25/24 months experience

There is no cover under this policy whilst the **insured vehicle** is being driven by or is in the charge of:

- any person under twenty-five years of age; or
- any person who is the holder of a provisional driving licence; or
- any person who has held a full driving licence to drive a private motor car issued either in a country within the **geographical limits** of this policy or a member country of the European Union for less than twenty-four months.

Endorsement E656: Protected No Claim Discount (4+ years entitlement)

Protected No Claim Discount applies in accordance with Section L of this policy.

Endorsement E657: Protected No Claims Discount (Less than 4 years NCD entitlement)

Protected No Claim Discount applies in accordance with Section L of this policy.

Endorsement E660: Limited mileage

Your premium reflects the total annual mileage you have declared on your **proposal form, statement of fact or statement of insurance**. If you exceed the declared mileage within a twelve month period, **you** will be responsible for the first £500 of any claim(s) under Sections A and B of this Policy. This **excess** is in addition to any other **excess(es)** shown in this policy document or on **your Policy Schedule** or in any other **endorsement**.

Endorsement E665: Personal benefits

The following benefits are excluded from your Policy:

- Section E - Personal Accident Benefits
- Section F - Personal Belongings
- Section G - Medical Expenses

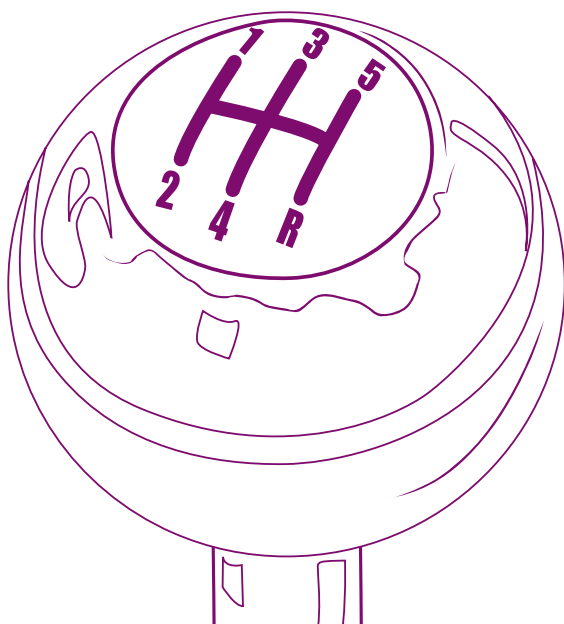

Our Service Commitment

What to do if you have a complaint

We are dedicated to delivering a first class level of service to all of our policyholders. However, we accept that things can occasionally go wrong and would rather be told about any concerns you have so that we can take steps to make sure the service you receive meets your expectations in the future.

If a dispute regarding your policy or claim arises and cannot be resolved by reference to your insurance intermediary the following explains the procedures for resolving your complaint:

The resolution of complaints in relation to your policy (or any claim made under it) is delegated to our service providers in the United Kingdom, Markerstudy Limited. If you have a complaint, please contact our service providers at the address below:

Complaints Handling
Markerstudy Limited
PO Box 420
Tunbridge Wells
Kent
TN2 9LT
Tel: 0844 874 0633
Email: complaints@markerstudy.com

When contacting Markerstudy Limited please provide:

- A policy number and/or claim number.
- An outline of your complaint.
- A contact telephone number.

Our service providers will make every effort to resolve your complaint immediately. If they cannot resolve your complaint by the end of the next working day they will acknowledge your complaint within five working days of receipt and do their best to resolve the problem within four weeks by sending you a final response letter. If they are unable to do so, they will write to advise you of progress and will endeavour to resolve your complaint in full within the following four weeks. If they are still unable to provide you with a

final response at this stage, they will write to you explaining why and advise when you can expect a final response. At this point you may refer your complaint to The Financial Ombudsman Service at the following address:

The Financial Ombudsman Service
South Quay Plaza
183 Marsh Wall
London
E14 9SR

You have the right of referral within six months of the date of your final response letter.

Whilst we and our UK service providers are bound by the decision of the Financial Ombudsman Service, you are not. Following the complaints procedure above does not affect your right to take legal action.

Customer feedback

If you have any suggestions or comments about our cover or the service we have provided please write to our UK service providers:

Operational Standards
Markerstudy Limited
PO Box 420
Tunbridge Wells
Kent
TN2 9LT

We always welcome feedback to enable us to improve our products and services.

Telephone Recording

For our joint protection telephone calls may be recorded and monitored by us.

Financial Services Compensation Scheme

Markerstudy Insurance Company Limited is a member of the Financial Services Compensation Scheme (FSCS). You may be entitled to compensation from this scheme if we cannot meet our liabilities under this policy.

Further information about the scheme is available on the FSCS website at www.fscs.org.uk or by writing to:

FSCS
7th Floor
Lloyd's Chambers
Portsofen Street
London
E1 8BN

Your insurance intermediary

In the event that we are unable to continue to trade with your insurance intermediary because they have ceased to trade through bankruptcy or liquidation or in the event that their relevant FSA authorisation is revoked we reserve the right to pass your policy and all details on to another intermediary. If you do not wish this to happen then please put your request in writing to us.

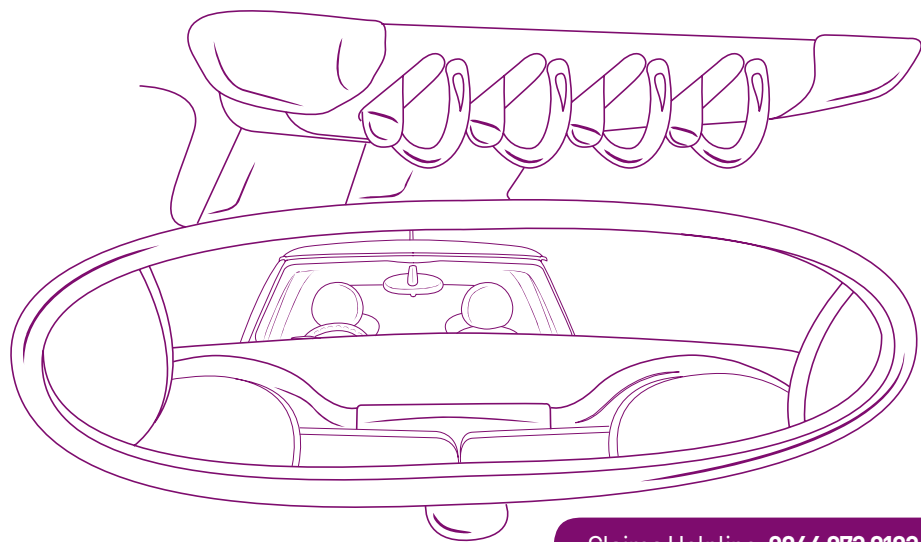

Data Protection and Sharing Information with Other Organisations

Data Protection

We are governed by the Data Protection legislation applicable in both the United Kingdom and Gibraltar. Under this legislation we are required to tell you the following information. It explains how we may use your details and tells you about the systems we have in place that allow us to detect and prevent fraudulent applications and claims. The savings that we make help us to keep premiums and products competitive.

Insurance Administration

Information you supply may be used for the purposes of insurance administration by the insurer and its agent, by re-insurers and your intermediary. In assessing any claims made, insurers may undertake checks against publicly available information such as electoral roll, county court judgement, bankruptcy or repossessions. Information may also be shared with other insurers either directly or via those acting for the insurer such as loss adjusters or investigators.

Information on Products and Services

We may use the details you have provided to send you information about our other products and services or to carry out research. We may contact you by letter, telephone or e-mail. Please be reassured that we won't make your personal details available to any companies outside the Markerstudy Group to use for their own marketing purposes. If you would prefer not to receive information from us or those companies who participate in research on our behalf, simply write to the Data Protection Officer:

Data Protection Officer
Markerstudy Limited
Markerstudy House
45 Westerham Road
Bessels Green
Sevenoaks
Kent
TN13 2QB

Motor Insurance Database

Your policy details will be added to the Motor Insurance Database (MID), run by the Motor

Insurers' Bureau (MIB). MID and the data stored on it may be used by certain statutory and/or authorised bodies including the police, the DVLA, the DVLNI, the Insurance Fraud Bureau and other bodies permitted by law for purposes not limited to but including:

- Electronic Licensing.
- Continuous Insurance Enforcement.
- Law enforcement (prevention, detection, apprehension and/or prosecution of offenders).
- The provision of government services and or other services aimed at reducing the level and incidence of uninsured driving.

If you are involved in an accident (in the UK or abroad), insurers and/or the MIB may search the MID to obtain relevant information. Persons (including his or her appointed representatives) pursuing a claim in respect of a road traffic accident (including citizens of other countries) may also obtain relevant information which is held on the MID.

It is vital that the MID holds your correct registration number. If it is incorrectly shown on the MID you are at risk of having your vehicle seized by the police. You can check that your correct registration details are shown on the MID at www.askmid.com.

Fraud Prevention, Detection and Claims History

In order to prevent and detect fraud we may at any time share information about you with other organisations and public bodies including the police. We may check and/or file your details with fraud prevention agencies and databases, and if you give us false or inaccurate information and we suspect fraud, we will record this.

We and other organisations may also search these agencies and databases to:

- Help make decisions about the provision and administration of insurance, credit and related services for you and members of your household.
- Trace debtors or beneficiaries, recover debt, prevent fraud and to manage your accounts or insurance policies.

- Check your identity to prevent money laundering, unless you furnish us with other satisfactory proof of identity.

In addition we may undertake credit searches and conduct additional fraud searches.

Claims History

Insurers pass information to the Claims and Underwriting Exchange Register, run by Insurance Database Services Ltd (IDS Ltd) and the Motor Insurance Anti-Fraud and Theft Register, run by the Association of British Insurers (ABI). The aim is to help us to check information provided and also to prevent fraudulent claims. Under the conditions of your policy you must tell us about any Insurance related incidents (such as fire, water damage, theft or an accident) whether or not they give rise to a claim. When you tell us about an incident we will pass information relating to it to these databases. We may search these databases when you apply for insurance, in the event of any incident or claim, or at time of renewal to validate your claims history or that of any other person or property likely to be involved in the policy or claim.

Other Insurers

We may pass information about you and this policy to other insurance companies with which we either reinsure our business or who are dealing with a claim made under this policy. In addition, information may be passed to other insurance related organisations in common with industry practice. These companies may be located in countries outside the UK but within the European Economic Area ("EEA"). We may also share data with other group companies who may be located outside of the EEA.

Sensitive Data

In order to assess the terms of the insurance contract or administer claims which arise, we will need to collect data which the Data Protection Act defines as sensitive such as medical history or criminal convictions. We will not use this data except for the specific purpose for which you provide it and to provide the services described in your policy booklet.

On payment of a small fee you are entitled to receive a copy of the information we hold about you. If you have any questions, or you'd like to find out more about this notice you can write to the Data Protection Officer:

Data Protection Officer
Markerstudy Limited
Markerstudy House
45 Westerham Road
Bessels Green
Sevenoaks
Kent
TN13 2QB

Accident Cards and Numbers to Call

Had an accident?

We're here to get you back on the road.

The procedure outlined below must be followed for all accidents, regardless of who was responsible. Even if you do not intend to make a claim for the damage to your vehicle you must still report the accident to us.

Delay in notification may invalidate your right to claim.

At the roadside? Call 0845 266 8846

To obtain immediate assistance at the roadside call our Roadside Priority Claims Helpline on 0845 266 8846.

Our UK based experienced advisors will take initial claim details and discuss recovery of your vehicle.

Unable to call from the roadside? Call 0844 873 8183

If you are unable to call from the roadside you must call our 24 hour Claims Helpline on 0844 873 8183 as soon as it is safe to do so.

Please call within 24 hours of the accident, but ideally within 1 hour.

Calling us straightaway provides you with benefits which may include the following (dependant on the level of policy cover you have):

- **FREE** courtesy car while your car is being repaired (subject to availability).
- Windscreen repair/replacement.
- **FREE** collection and re-delivery.
- **FREE** car cleaning service.
- Repairers' work guaranteed for three years.

Does the accident involve a third party?

- Fill in the accident card provided and pass to the third party.
- If you are calling from the roadside we may ask to speak to the third party, or ask you to request them to contact us on 0844 873 8189 within 1 hour.
- The third party may be entitled to a number of services free of charge (dependant on fault).

Please remove these accident cards and keep them somewhere safe.



Other driver's details

Name: _____
Address: _____

Contact no: _____
Email: _____
Vehicle registration no: _____
Insurer & Policy no: _____



Your details

Name: _____
Address: _____

Contact no: _____
Email: _____
Vehicle registration no: _____
Markerstudy Policy no: _____



Private Car Insurance Policy

www.markerstudy.com

Had an accident?

Call our Roadside Priority Helpline on **0845 266 8846**

Call within 1 hour, or within 24 hours at the very latest.

You may be entitled to a **FREE** courtesy car, **FREE** collection and delivery, and we can provide a windscreen replacement service.

Your Policy Number:

If the accident involved another driver, please fill in their details on the reverse of this card.

Other action to take:

- Take pictures of damage and accident location
- Take details of any witnesses
- **Do not** admit responsibility



Had an accident?

Please give this card to the other driver,
with your details filled in on the reverse.

To the other driver:

You could be entitled to a number of services
FREE OF CHARGE.

Whether you are at fault or not, contact us on
0844 873 8189

Let us take the stress away... Call us now!



All correspondence should be addressed to:

Markerstudy Limited, Markerstudy House, 45 Westerham Road, Bessels Green, Sevenoaks, Kent TN13 2QB.

Markerstudy Limited is an appointed service provider to but is not an agent of Markerstudy Insurance Company Limited. Markerstudy Limited is authorised and regulated by the Financial Services Authority (FSA Number 312214). Registered in England and Wales Number 03969511. Registered Office: Markerstudy House, 45 Westerham Road, Bessels Green, Sevenoaks, Kent TN13 2QB.

Markerstudy Insurance Company Limited is regulated by the Gibraltar Financial Services Commission and subject to a limited regulation by the Financial Services Authority in respect of underwriting insurance business in the UK (FSA Number 206322). Registered in Gibraltar Number 78789. Registered Office: 846-848 Europort, Gibraltar.